



CLS8.0

High Quality Ceiling Speaker 高音质吸顶扬声器



CLS8.0 is a high-quality ceiling speaker with its interior decoration perfectly integrated to complement each other. The panel is made of high-strength ABS material. Simple and convenient power setting, easy to operate. It is suitable for many occasions such as department stores, schools, offices, hotels and restaurants.

CLS8.0是一款高音质吸顶扬声器. 它采用美观的黑色涂层和白色网罩, 时尚精巧的外型可与现代化的室内装潢完美融合, 相得益彰。面板采用高强度的ABS材料。简单方便的功率设置, 操作简单。适合于多种场合例如在商店、百货公司、学校、办公室、酒店和餐馆等等的内嵌式音响应用场合。

Characteristic特点

- Exceptional voice and music reproduction
- 非凡的语音和音乐再现效果
- Simple and convenient power setting
- 简单方便的功率设置
- Easy and fast installation and flexible assembly
- 安装方便快捷, 装配灵活
- CE compliant
- 符合CE标准

Three View三视图

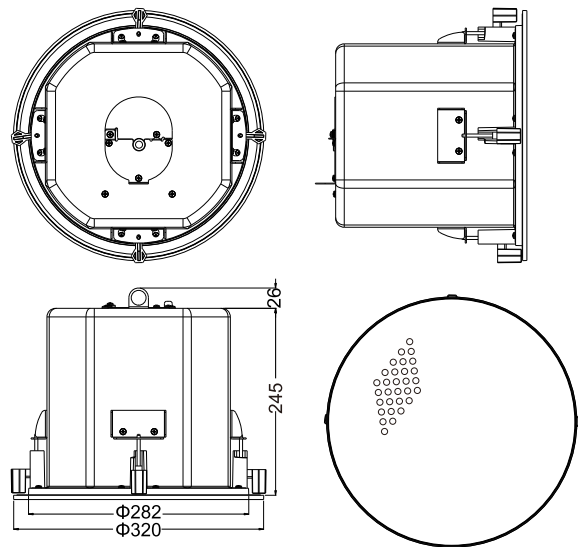

Measurement尺寸 (Unit单位: mm毫米)

Technical Specification 技术规格

Mechanical Specification	指标
Maximum Power 最大功率	90W
Rated Power 额定功率 定阻(8Ω)	60W
Sensitivity 灵敏度(1m/1W)	94dB
Maximum Sound Pressure 最大声压级(1m/60W)	111dB
Frequency Response 频响范围	90Hz ~ 15kHz
Open Angle 开放角度(1kHz / -6dB)	150°
Connector 连接器	RJ45或EU 4PIN欧式端子
Appearance Specification	机械指标
Product Size 产品尺寸	Φ320 x 245mm
Open Hole Size 开孔尺寸	Φ290mm
Baffle/Back Bucket 面板/后桶	ABS/铁
Mesh Cover 网罩	Metal 铁网
Product Weight 产品重量	5.3kg
Product Color (Back Shell) 产品颜色(后壳)	White 白色(RAL9016)
Product Color (Back Shell) 产品颜色(后壳)	Black 哑黑色(RAL9004)
Horn Unit Size 喇叭单元尺寸	Low 低音: 8" High 高音: 1"
Environmental Specification	环境要求
Operating Temperature 操作温度	-25℃ to +55℃
Storing Temperature 存储温度	-40℃ to +70℃
Relative Humidity 相对湿度	<95%

Connection Diagram 接线图

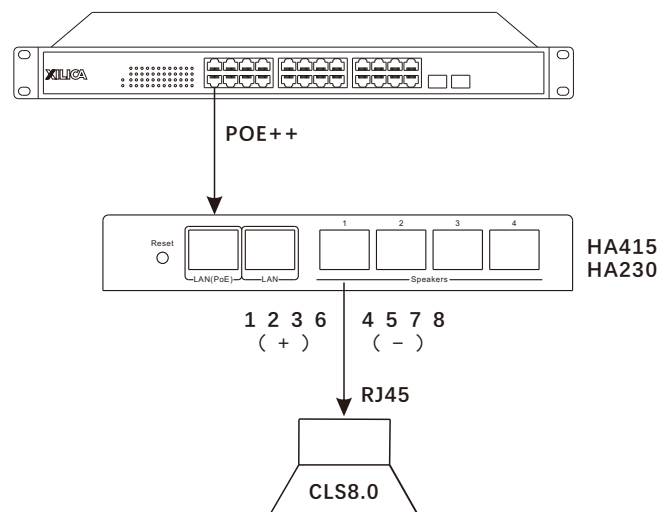

Frequency Response Diagram 频率响应图

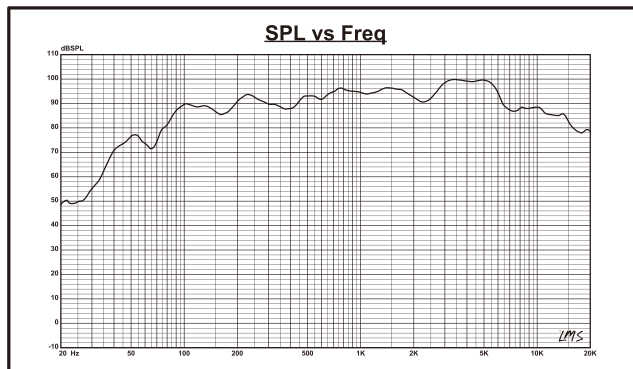

Impedance Diagram阻抗图

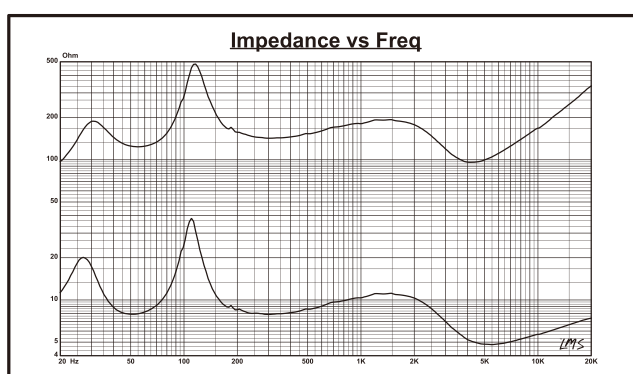

Directivity Diagram指向性图

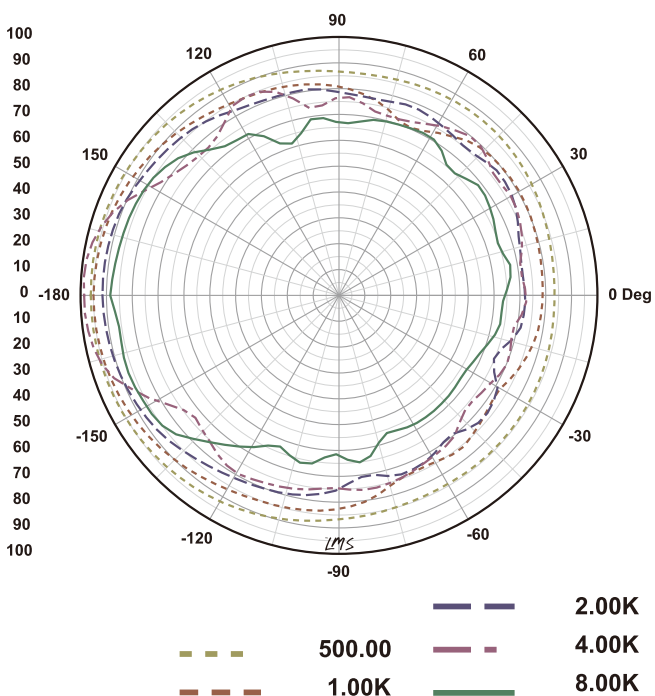

Installation Guide 安装说明

1. Open one $\Phi 290\text{mm}$ hole on the ceiling
在天花板上开一个 $\Phi 290\text{mm}$ 的孔位。

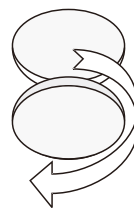

2. Fix the safety rope to the reinforcement or bolt near the horn opening to avoid horn falling
将安全绳固定到喇叭开口附近的钢筋或螺栓上，以避免喇叭掉落。

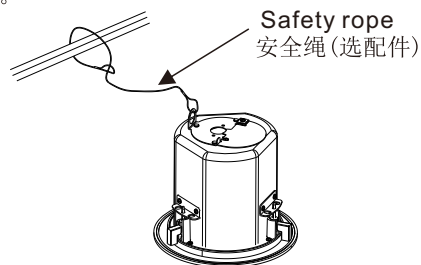

3. Take out the baffle
将产品网拆出。

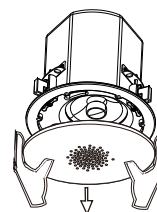

4. Connect the audio signal cable, screw tight to the ceiling according to the pre-opened hole
连接音频信号线，按预先开好的孔将产品安装到天花板上，并拧上螺丝 使卡舌与天花板固定。

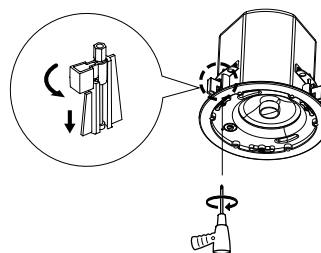

5. Put back the baffle
将网重新装上。

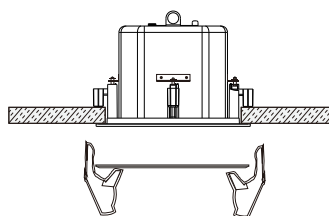

Xilica Corporation

3455 Bethesda Road, Stouffville,
Ontario Canada. L4A 3Z4
www.xilica.com or cn.xilica.com